

CONNECTORS, straight

autoclavable, Material: PSU



REF 60-12-110 Box 10



REF 60-12-300 Box 10



REF 60-12-400 Box 10



REF 60-50-002 Box 10



REF 60-12-501 Box 10



REF 60-50-005 Box 10



REF 60-50-003 Box 10



REF 60-12-601 Box 10

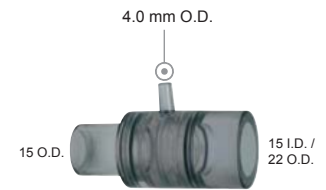

REF 60-12-602 Box 10



REF 60-12-200 Box 10

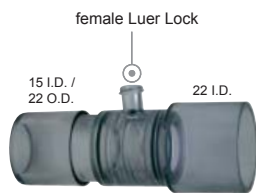

REF 60-12-201 Box 10

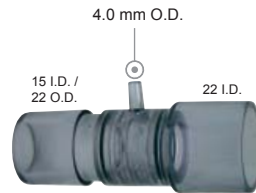

REF 60-12-202 Box 10

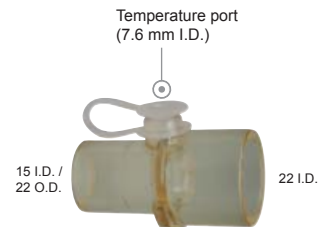

REF 60-12-203 Box 10

CONNECTOR, straight

autoclavable, Material: Aluminium



for O₂-Tubing

REF 60-71-002 Box 10

T-CONNECTORS

autoclavable, Material: PSU



REF 60-11-500 Box 10

REF 60-11-503 Box 10

REF 60-11-510 Box 10

Y-CONNECTORS, straight

autoclavable, Material: PSU



REF 60-11-200 Box 10

REF 60-10-100 Box 10

REF 60-10-101 Box 10

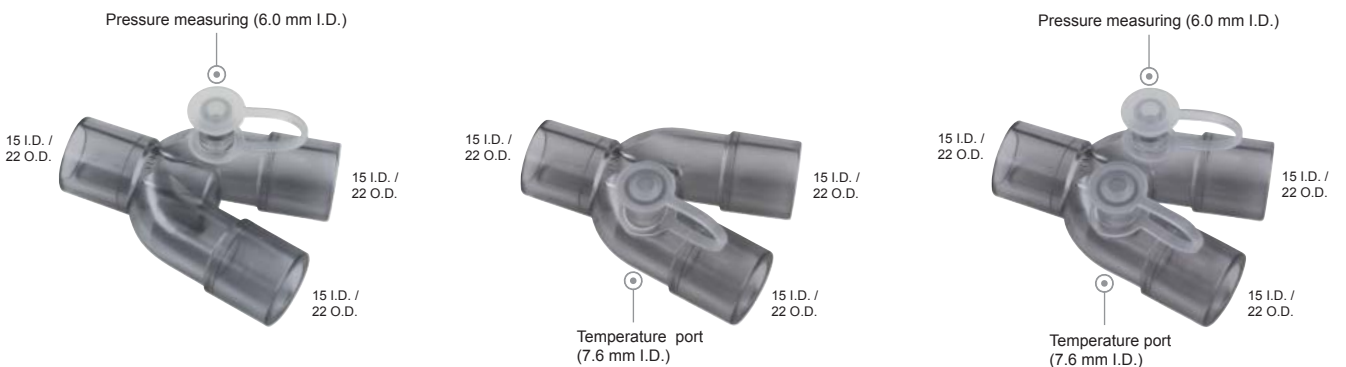

REF 60-11-202 Box 10

REF 60-11-203 Box 10

REF 60-11-204 Box 10

ACCESSORIES

Luer Lock Connection, right angled
Material: Nylon, autoclavable

REF 60-11-888 Box 10



Plug, Color: clear
Material: Silicone, autoclavable

REF 60-11-999 Box 10



CATHETER MOUNT TUBINGS

autoclavable, Material: Silicone (Connecting Tubing), PSU (Connector)

Length: 13 cm	Length: 20 cm	Box
REF 65-60-130	REF 65-60-200	10

Length: 13 cm	Length: 20 cm	Box
REF 65-80-130	REF 65-80-200	10

Length: 16 cm	Length: 23 cm	Box
REF 65-80-160	REF 64-80-230	10

Length: 13 cm	Length: 20 cm	Length: 33 cm	Box
REF 65-65-130	REF 65-65-200	REF 65-65-330	10

Length: 13 cm	Length: 20 cm	Length: 33 cm	Box
REF 65-85-130	REF 65-85-200	REF 65-85-330	10

Length: 16 cm	Length: 23 cm	Box
REF 65-85-160	REF 64-85-230	10

Length: 13 cm	Length: 20 cm	Box
REF 65-68-130	REF 65-68-200	10

Length: 13 cm	Length: 20 cm	Box
REF 65-88-130	REF 65-88-200	10

Length: 16 cm	Length: 23 cm	Box
REF 65-88-160	REF 64-88-230	10

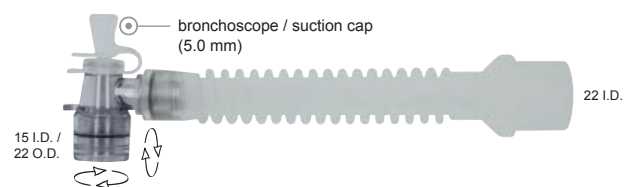
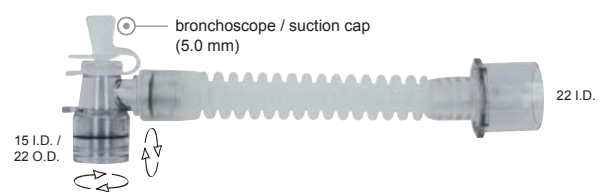
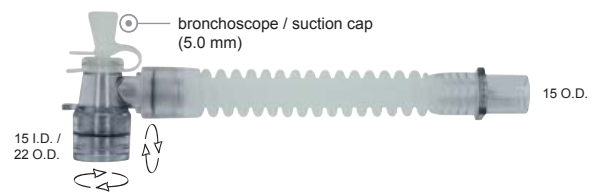
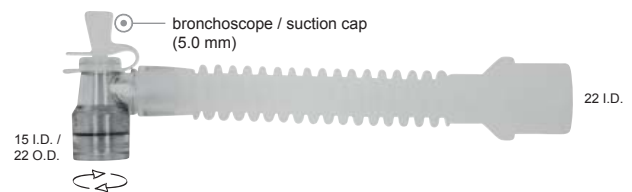
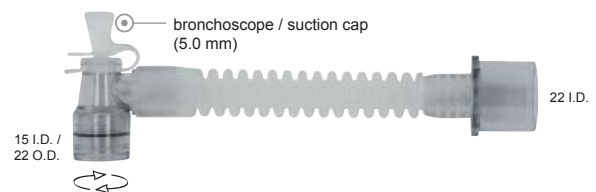
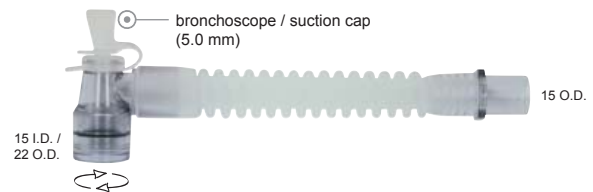
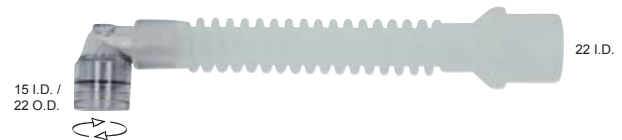

19 MM RESPIRATION TUBINGS FOR ADULTS

autoclavable, Material: Silicone

Length	Color: green	Color: transparent	Box
30 cm	REF 66-22-030	REF 66-22-030tr	1
40 cm	REF 66-22-040	REF 66-22-040tr	1
60 cm	REF 66-22-060	REF 66-22-060tr	1
80 cm	REF 66-22-080	REF 66-22-080tr	1
90 cm	REF 66-22-090	REF 66-22-090tr	1
110 cm	REF 66-22-110	REF 66-22-110tr	1
130 cm	REF 66-22-130	REF 66-22-130tr	1
150 cm	REF 66-22-150	REF 66-22-150tr	1
180 cm	REF 66-22-180	—	1
200 cm	REF 66-22-200	—	1

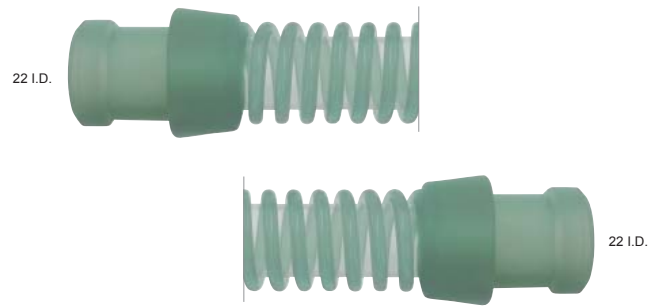

16 MM "LIGHTWEIGHT TUBINGS" FOR ADULTS

autoclavable, Material: Silicone, Color: green

- light weight due to smaller tube and thinner coil
- high stability
- longer lasting than autoclavable plastic tubings

Length	REF	Box
30 cm	69-16-030	1
45 cm	69-16-045	1
60 cm	69-16-060	1
90 cm	69-16-090	1
110 cm	69-16-110	1
130 cm	69-16-130	1
150 cm	69-16-150	1
180 cm	69-16-180	1
200 cm	69-16-200	1

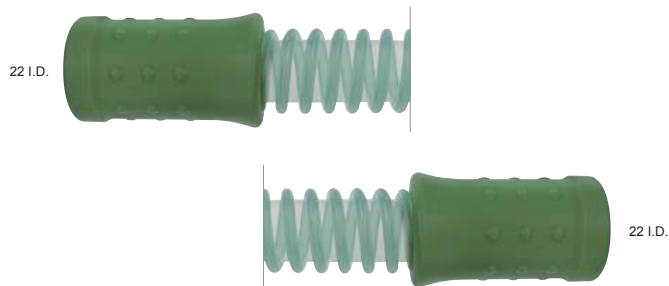

ACCESSORIES

autoclavable

Hook

for 9 mm / 19 mm
Respiration Tubings
Material: Silicone

REF 66-00-002 Box 5



Connector, straight

to connect and extend
Respiration Tubings with
22 mm cuffs, Material: POM

REF 60-15-110 Box 1



9 MM RESPIRATION TUBINGS FOR PEDIATRICS

autoclavable, Material: Silicone, Color: green

10 mm Cuffs

Length	REF	Box
25 cm	66-10-025	1
45 cm	66-10-045	1
60 cm	66-10-060	1
85 cm	66-10-085	1
110 cm	66-10-110	1
130 cm	66-10-130	1
150 cm	66-10-150	1
200 cm	66-10-200	1

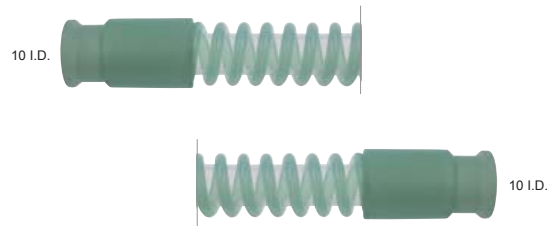

10 mm / 22 mm Cuffs

Length	REF	Box
25 cm	66-11-025	1
45 cm	66-11-045	1
60 cm	66-11-060	1
85 cm	66-11-085	1
110 cm	66-11-110	1
130 cm	66-11-130	1
150 cm	66-11-150	1
170 cm	66-11-170	1
200 cm	66-11-200	1

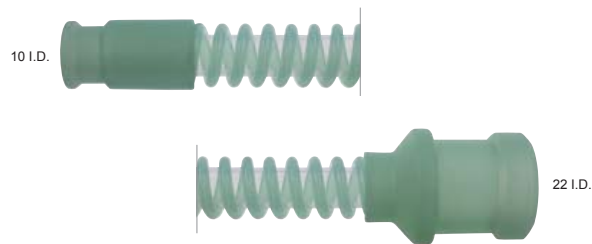

22 mm Cuffs

Length	REF	Box
25 cm	66-12-025	1
60 cm	66-12-060	1
85 cm	66-12-085	1
110 cm	66-12-110	1
130 cm	66-12-130	1
150 cm	66-12-150	1
170 cm	66-12-170	1
200 cm	66-12-200	1

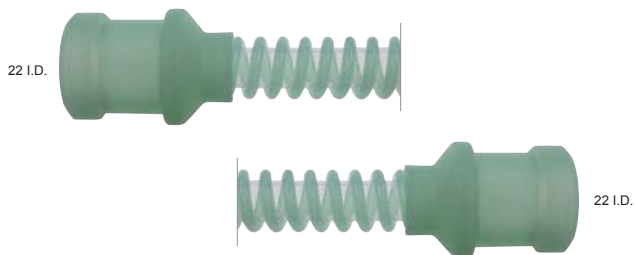

9 MM "LIGHTWEIGHT TUBINGS" FOR PEDIATRICS

autoclavable, Material: Silicone, Color: green

- light weight due to smaller tube and thinner coil
- high stability
- longer lasting than autoclavable plastic tubings

Length	REF	Box
25 cm	69-10-025	1
45 cm	69-10-045	1
60 cm	69-10-060	1
90 cm	69-10-090	1
110 cm	69-10-110	1
130 cm	69-10-130	1
150 cm	69-10-150	1

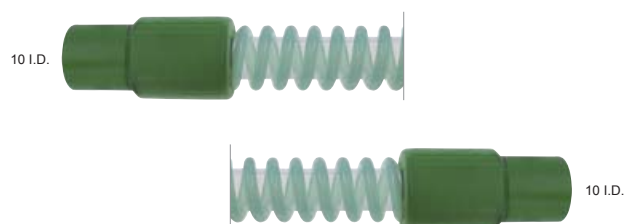

REBREATHING BAGS

with 22 mm cuff and loop

autoclavable, Material: Silicone, Color: transparent

Standard

Size	REF	Box
500 ml	66-00-011	1
1000 ml	66-00-015	1
1500 ml	66-00-012	1
2300 ml	66-00-013	1
3000 ml	66-00-014	1



with open tube connection and cap

Size	REF	Box
500 ml	66-00-041	1
1000 ml	66-00-045	1
1500 ml	66-00-042	1
2300 ml	66-00-043	1
3000 ml	66-00-044	1



with 5 mm hole

Size	REF	Box
500 ml	66-00-441	1
1000 ml	66-00-445	1
1500 ml	66-00-442	1
2300 ml	66-00-443	1
3000 ml	66-00-444	1



WATER TRAPS

with 55 ml canister

autoclavable, Material: PSU



REF 66-40-500 Box 6



REF 66-40-520 Box 6



REF 66-40-510 Box 6



Respirator Water Trap

REF 66-40-511 Box 6